

# #37020 Schiebepflanenwagen DB Ep. V

## Tarpaulin Car · Wagon bâché à bogies

### Staalrollenwagen Shimmns

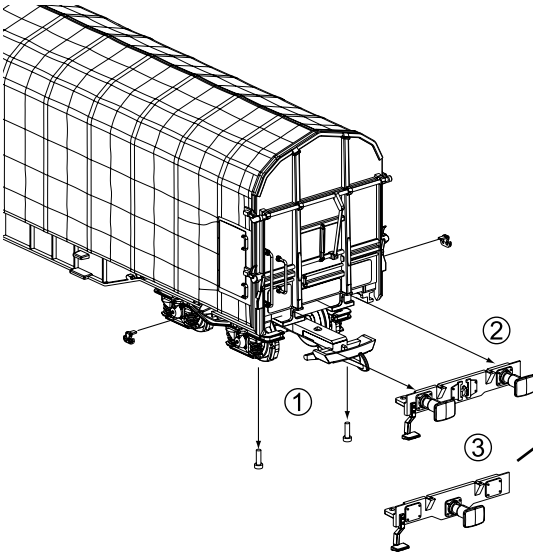

wahlweise: #37700-02  
(nicht enthalten)  
alternatively: spare part  
#37700-02  
(not included)  
au choix: pièce détachée  
#37700-02  
(ne sont pas inclus)  
naar keuze: onderdeel  
#37700-02  
(niet inbegrepen)



37020-90-7000 © PIKO 2026

## ERSATZTEILE

Spare parts · Pièces détachées · Reserveonderdelen

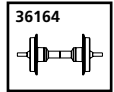
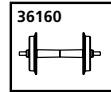
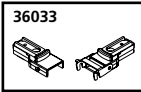
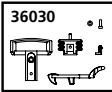
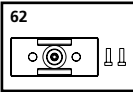
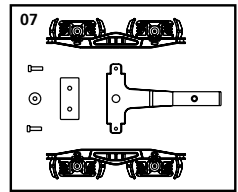
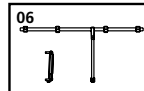
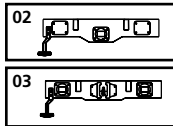
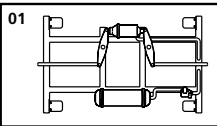

Nr:	Bezeichnung:	Description:	Désignation:	Beschrijving:	PG*
37700-01	Bremsgestänge	Brake rods	Conduites de freins	Remsysteem	8
37700-02	Pufferbohle für Mittelpuffer	End Beam for central buffer	Traverse de tamponnement (tampon central)	Bufferbalk (middenbuffer)	8
37700-03	Pufferbohle für 2 Puffer	End Beam for 2 buffers	Traverse de tamponnement (2 tampons)	Bufferbalk (2 buffers)	8
37700-04	Puffer (2 St.)	Buffers (set of 2)	Tampons (2 unités)	Buffer (2 stuks)	6
37732-05	Handstangen	Handrails	Poignées	Handgrepen	8
37700-06	Hydraulikgestänge	Hydraulic rod	Conduites hydrauliques	Hydraulische bediening	8
37700-07	Drehgestell	Bogie	Bogie	Draaistel	12
37700-39	Seilanker (4 St.)	Anchor (set of 4)	Ancre (4 pièces)	Anker (4 stuks)	8
37320-62	Lagerplatte (Querrippe)	Bearing plate	Plaque pour fixation	Lagerplaat	7
	<b>Standard Ersatzteile</b>	<b>Catalog Parts</b>	<b>Pièces détachées standard</b>	<b>Standaardonderdelen</b>	
36030	Kupplung komplett	Standard Coupler	Attelage, complet	Koppeling, volledig	
36033	Ganzzug-Kupplung	Rigid Coupler	Attelage	Koppeling	
36090	Schrauben-Set (20-tlg./5 Größen)	Screws (5 Sizes, 20 Pcs)	Bogies „Bettendorf“ (2 unités)	Set schroeven (20-delig)	
36160	Radsatz Kunststoff (2 St.)	Plastic Wheelset (set of 2)	Essieux plastiques (2 unités)	Kunststof wielstel (2-delig)	
36164	Radsatz Metall (2 St.)	Metal Wheelset (set of 2)	Essieux métalliques (2 unités)	Metalen wielstel (2-delig)	