

# ERSATZTEILE

Spare parts · Pièces détachées · Parti di ricambio · Repuestos · 配件 · Reserveonderdelen · Запасные части

Bei Ersatzteilanforderung bitte immer die vollständige Ersatzteil-Nr. angeben.  
Hinweis: Für dieses Modell sind nur die unten aufgeführten Ersatzteile erhältlich!

Please order the wanted spare part with the complete spare part item number.  
Note: Only the spare parts listed below are available for this model!

Pour commander des pièces de rechange, ne pas oublier de donner le Numéro d'Article de la pièce demandée.  
Note: Seules les pièces demandée sont disponibles pour ce modèle!

订购配件时请附上完整的配件号码。注：这个模型，只有以下配件可订购！

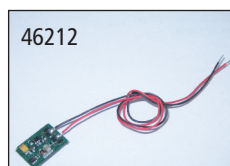
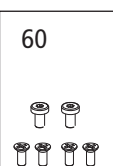
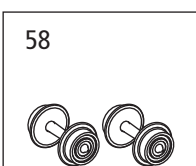
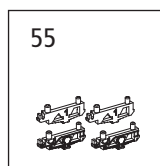
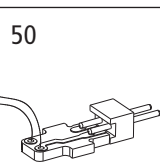
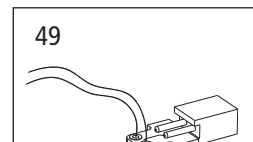
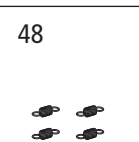
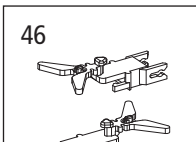
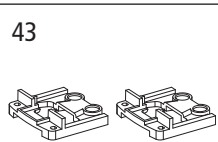
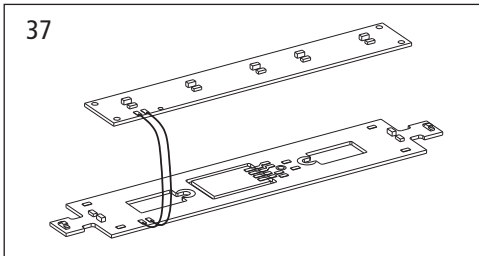
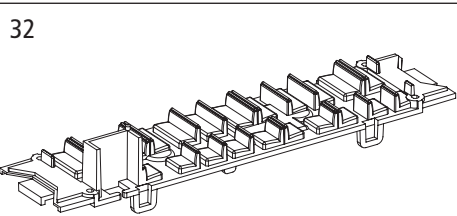
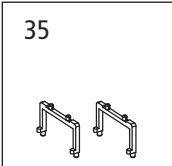
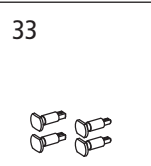
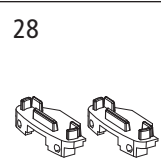
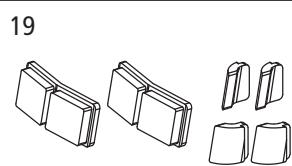
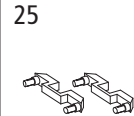
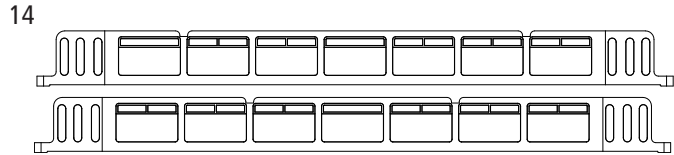

# Beiwagen 998

Middle Car 998 /

Side-car /

中间车 998



包装及说明书内包含重要信息, 请保留备用

Gehäuse leicht spreizen und nach oben abziehen  
Extend the body and pull slightly upward  
Boîtiers écartent et retirer en haut  
把车身轻轻撑开并向上提起

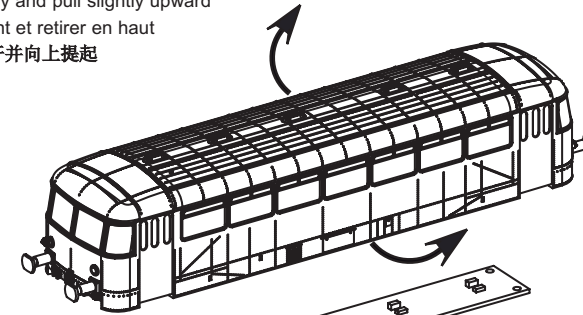

Funktionsdecoder mini # 46212 /  
Fonction decoder # 46212 /  
Fonctionnement numérique # 46212 /  
功能解码器 # 46212

bei Digitalbetrieb Leiterplatten-Teil  
ausbrechen /  
for Digital operation PCB part break out /  
pour fonctionnement numérique partie éclater /  
数字解码器安装位置

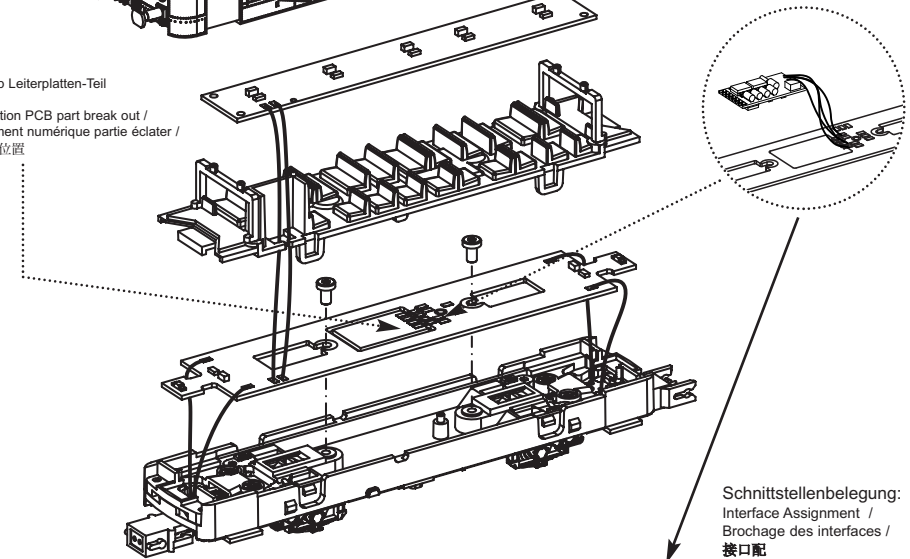

Schnittstellenbelegung:  
Interface Assignment /  
Brochage des interfaces /  
接口配

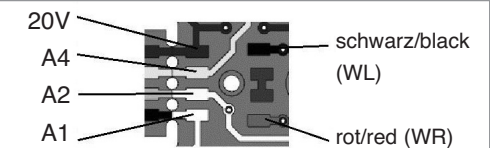

40680-90-7001

PIKO Spielwaren GmbH · Lutherstraße 30 · 96515 Sonneberg · GERMANY

德国比高有限公司 · 德国图林根州索内堡市路德街30号

## Ersatzteile

Spare parts · Pièces détachées · Parti di ricambio

Nr.:	Bezeichnung:	Description:	Désignation:	Descrizione:	PG*
40250-14	Seitenfenster	Side windows	Fenêtres latérales	Set finestrini	9
40680-19	Stirn- und Eckfenster	Front window + corner window	Fenêtres frontales et d'angles	Parabrezza e finestrini laterali	8
40680-25	Leuchtstäbe	Light bars	Conduit de lumière	Luci di posizione	6
40680-28	Stirnsitz	Front seat	Siège AV	sedile anteriore	7
40680-32	Sitze	Seating	Aménagement intérieur	Arredamento interno	8
40250-33	Puffer	Buffer	Tampons	Respingenti	6
40250-35	Halter Leiterplatte	PCB holder	Support de platine	Contatto	6
40680-37	Leiterplatte mit Beleuchtungsplatine und Kabel	Main board w lightboard and cables	Circuit imprimé complet	Corredo illuminazione	11
40680-43	Abdeckungen Kupplung	Cover coupling	Couvercle attelage	Copri gancio	6
40680-46	Kupplungen	Couplers	Timon d'attelage	Ganci	7
40250-48	Feder f. Kupplungen (4 Stck.)	Spring for coupler (set of 4)	Ressort pour timon (4 pcs)	Molle per ganci (set 4 pezzi)	7
40250-49	Leiterplatte Kupplung Buchse	Main board connector socket	Fiche électrique mâle	Corpo gancio di contatto	8
40250-50	Leiterplatte Kupplung Stecker	Main board connector plug	Fiche électrique femelle	Gancio di contatto elettrico	8
40680-55	Achshalter, rechts / links	Axle support, right / left	Flanc de bogie, droite / gauche	Supporto assali destro / sinistro	8
40250-58	Radsatz (2 Stck.)	Wheelset (2 pcs.)	Essieux (2 unités)	Set ruote (2 pezzi)	9
40250-60	Schrauben-Set	Screw-Set	Set de vis	Set viti	6
	<b>Ersatzteile aus unserem Standardprogramm</b>	<b>Spare parts standard range</b>	<b>Pièces détachées de notre programme standard</b>	<b>Pezzi di ricambio standard</b>	
46212	Funktionsdecoder mini	Function decoder small	Fonction décodeur petite	Decoder Funzione piccolo	

\*Catégorie de prix \*Preisgruppe \*price category \*Gruppo dei prezzi

Repuestos · 配件 · Reserveonderdelen · Запасные части

Nr.:	Descripción:	说明:	Omschrijving:	Описание:	PG*
40250-14	Ventana lateral	侧窗	Vensters zijwand	Боковые окна	9
40680-19	Ventana frontal y esquina	前窗+角窗	Voorzijde en hoek raam	Переднее окно + угол окна	8
40680-25	Barra difusora de luces	灯柱	Lichtgeleiders	Легкие баров	6
40680-28	Asiento frontal	前座	Soorstoel	переднее сиденье	7
40680-32	Asientos	座位	Stoelen	Рассаживание	8
40250-33	Topera	缓冲器	Buffers	буфер	6
40250-35	Soporte placa electrónica	线路板盖	Houder voor Hoofdprintplaat	PCB держатель	6
40680-37	Placa electrónica con placa luces y cables	线路板盖	Hoofdprintplaat VT met verlichtingsprintplaten en kabels	Материнская плата с световым табло и кабелей	11
40680-43	Tapa del enganche	盖子 挂钩	Drukgroep	Крышка сцепления	6
40680-46	Enganches	挂钩	Koppelingen	Муфты	7
40250-48	Muelle para enganche (4 u.)	弹簧-用于挂钩 (4套)	Koppelingsveer (4 stuks)	Весна для сцепления	7
40250-49	Placa electrónica hembra enganche	主板挂钩杯士	Hoofdprintplaat Koppeling struik	Разъёме Материнская плата	8
40250-50	Placa electrónica macho enganche	主板挂钩插头	Hoofdprintplaat Koppeling plug	Разъёме Материнская плата	8
40680-55	Soporte ejes derecho / izquierdo	轴支架, 右/左	Ashouder, rechts / links	Поддержка мост, вправо / влево	8
40250-58	Ejes (2 u.)	轮组 (2个)	Wielstel VS (2 stuks)	Колесная (2 шт.)	9
40250-60	Set tornillos	螺丝	Set schroeven	Винт-Set	6
	<b>Repuestos de nuestro programa standard</b>	<b>备用零件的标准范围:</b>	<b>Reserveonderdelen uit ons standaard programma</b>	<b>Запчасти от наших стандартных</b>	
46212	Función decodificador pequeña	函数解码器小	Funcie decoder klein	Функция декодер небольшой	

\*Grupo de precio \*价格表 \*Priscategorie \*ценевая категория